

# Cube Core Filter Grille

**DARE5-FG** Top Mounting & Bottom Mounting

**MOUNTING OPTIONS - A, B, C OR D**

Must Specify Both



- 1/2" x 1/2" x 1/2" eggcrate core has a high free area for minimum pressure loss
- Designed to fit most 1" filters (must be undersized 9/32")
- Neat appearance often matches luminaries
- Aluminum extruded frame with mechanically locked corners
- Available on 2" increments as standard
- Custom sizes available but extra charge may apply
- Durable powdercoat painted finish
- Available in White, Silver or Mill

TOP MOUNTING METHOD SPECIFIED FIRST (RECOMMENDED A & B ONLY)

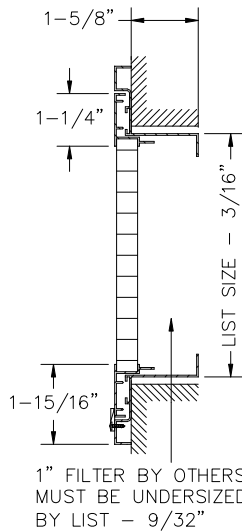
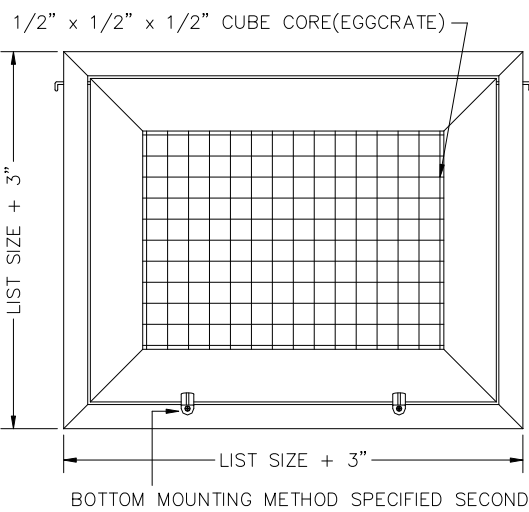

**A SPRING PINS**

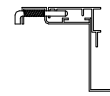
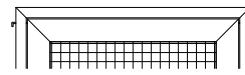

Grille easily removed from frame (recommended for top mounting only)

**B WIRE HINGE**

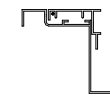
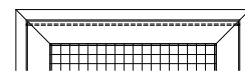

Grille NOT removable from frame (recommended for top mounting only)

**C NYLON THUMBSCREW**

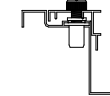
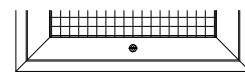

**D NYLON SCREEN TABS**

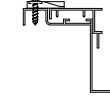

• **Note:** DARE5-FG A&D shown

• **Note:** 2+Filter can be specified by changing the suffix to -FG2  
4+Filter can be specified by changing the suffix to -FG4



DESCRIPTION	DARE5-FG <u>Top Mounting</u> & <u>Bottom Mounting</u>
FACE BLADES	1/2"x 1/2"x 1/2"+eggcrate
REAR BLADES	n/a
DAMPER	n/a
MATERIAL	Aluminum
COLOR	White/Silver/Mill

JOB NAME: \_\_\_\_\_

LOCATION: \_\_\_\_\_

ARCHITECT: \_\_\_\_\_

ENGINEER: \_\_\_\_\_

CONTRACTOR: \_\_\_\_\_