

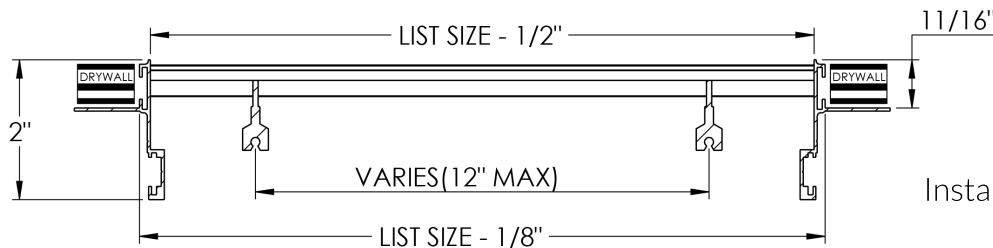

- Fully extruded, high quality aluminum construction for a stylish appearance.
- Hidden flange designed to be installed underneath drywall.
- Fixed blades parallel to the long dimension.
- Sections over 84" are joined for continuous lengths with aligning pins provided.
- Available on 1/2" increments as standard. Custom sizes available down to 1/16" increments.
- Available with durable powder coat finish.

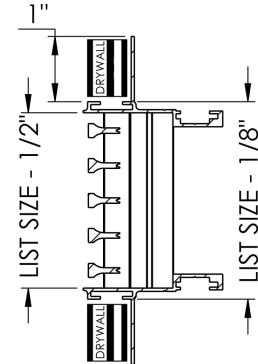
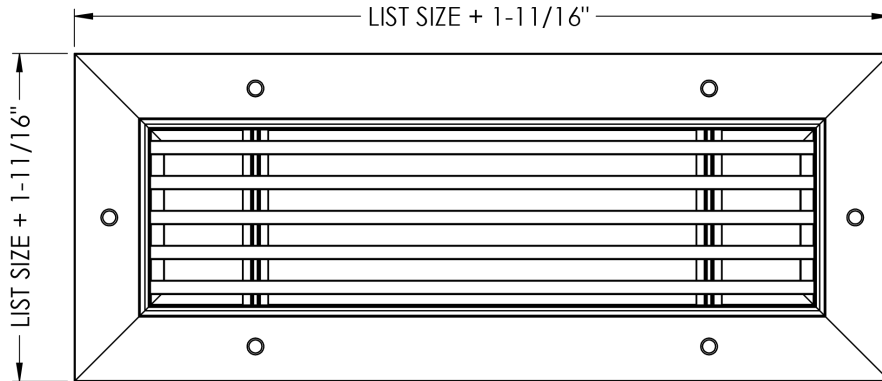

Installed before the drywall.

1. Specify Quantity

2. Specify the Length x Height Dimensions

Available on 1/2" increments as standard. Custom sizes down to 1/16" increments.

_____ x _____ inches mm

Invisible lip design allows for a true frame-less appearance, and easier installation.

3. Select a Blade Option

- 00 - 0° Deflection
- 01 - 0° Pencil Proof
- 15 - 15° Deflection
- 30 - 30° Deflection
- 82 - 0° Air Flow
- 84 - 0° Heel Proof

4. Select a Mounting Option

- A - Screw Holes
- C - Concealed Brackets
- TB - No Mounting

5. Select a Finish

- W - White
- S - Silver
- B - Brown
- M - Mill
- FB - Flat Black
- Special: _____

6. Select a Lead Time

- 3 Day Ship
- Next Friday
- Standard Delivery



Additional Option
See specific submittal pages for options listed below.
 D - Opposed Blade Damper

Project / Location:
Architect:
Engineer:
Contractor:



Scan for more product information.

BLADE OPTIONS

-00

0° 13/64" blades on 1/2" centers

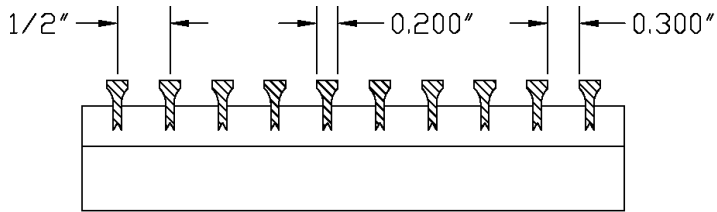

-01

0° 1/4" blades on 1/2" centers

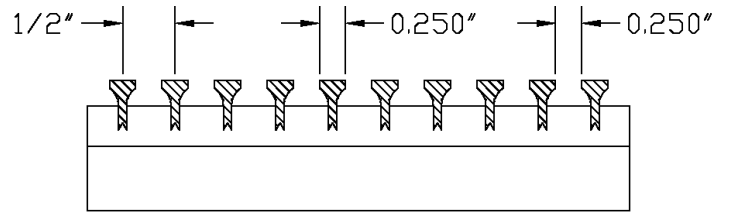

-15

15° 13/64" blades on 1/2" centers

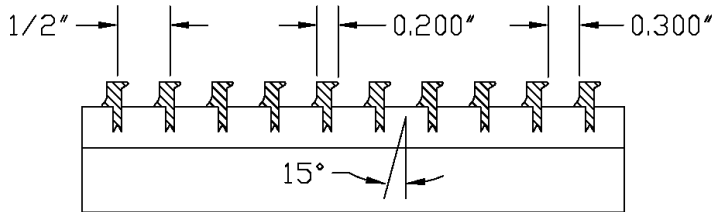

-30

30° 13/64" blades on 1/2" centers

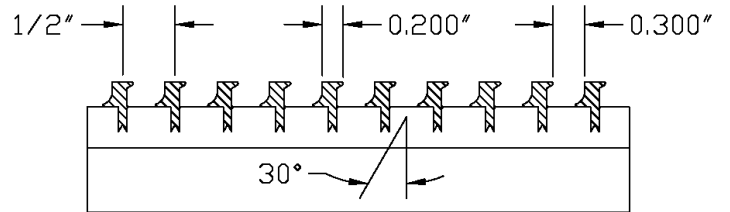

-82

0° 1/8" blades on 1/2" centers

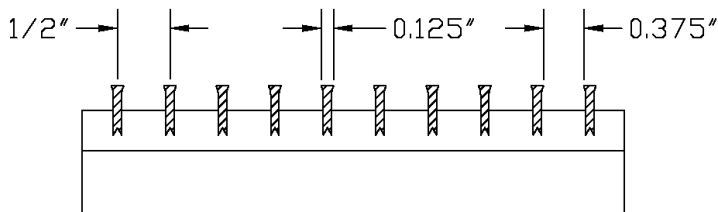

-84

0° 1/8" blades on 1/4" centers

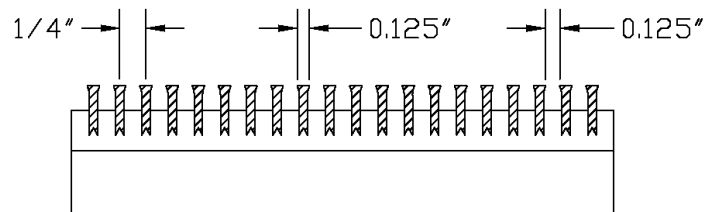

Scan for more
product
information.

MOUNTING

-A

Screw Holes

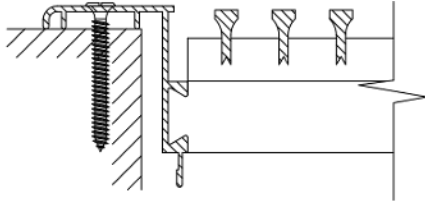

Color matched screws with countersunk screw holes.

-B

Spring Clips

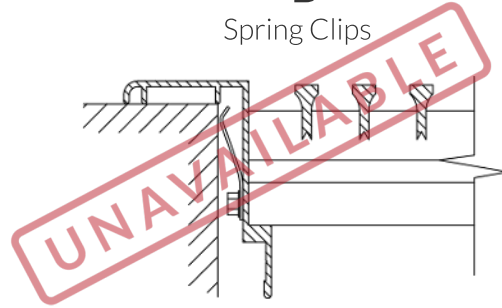

Hidden clips behind the flange to keep the grille secure in the opening. Only suitable for floor & sill applications.

-C

Concealed Brackets

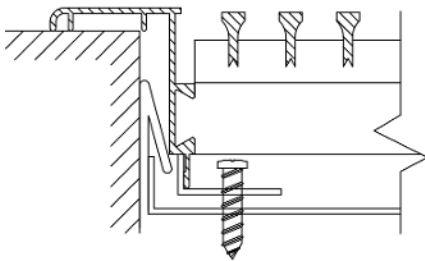

Product is fastened to duct-mounted brackets, which are concealed behind the blades.

-D

Sidewall Screw Holes

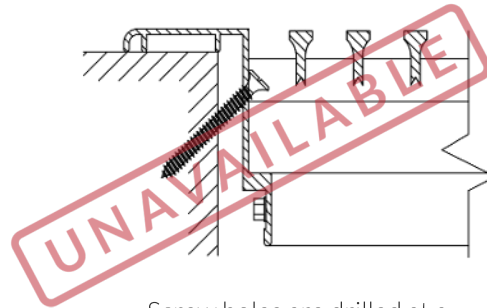

Screw holes are drilled at a 45° angle on inner flange. Only available with Removable Core.

-TB

No Mounting

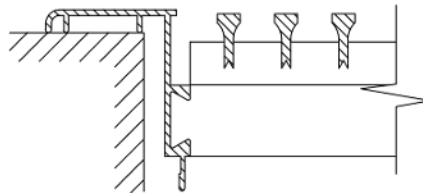

Designed for lay-in ceiling and custom applications. For lay-in, order 2" under to account for flange.

e.g. 22" x 10" will have O.D. 23-11/16" x 11-11/16" and fit a standard 24" x 12" T-bar opening.



Scan for more product information.