

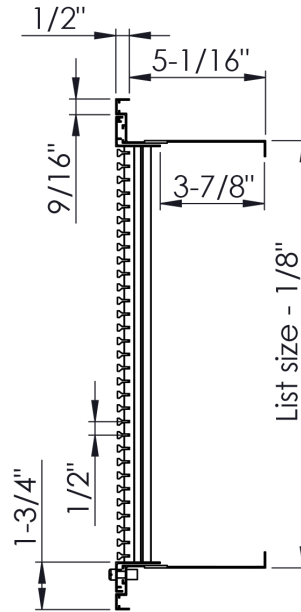

- Complements the appearance of our Bar Linear grilles.
- Fully-extruded, architectural aluminum construction.
- Fixed blades parallel to the length.
- Designed to fit a standard 4" filter depth.
- Available on 2" increments as standard. Custom sizes available down to 1/16" increments.
- Available with durable powder coat finish.

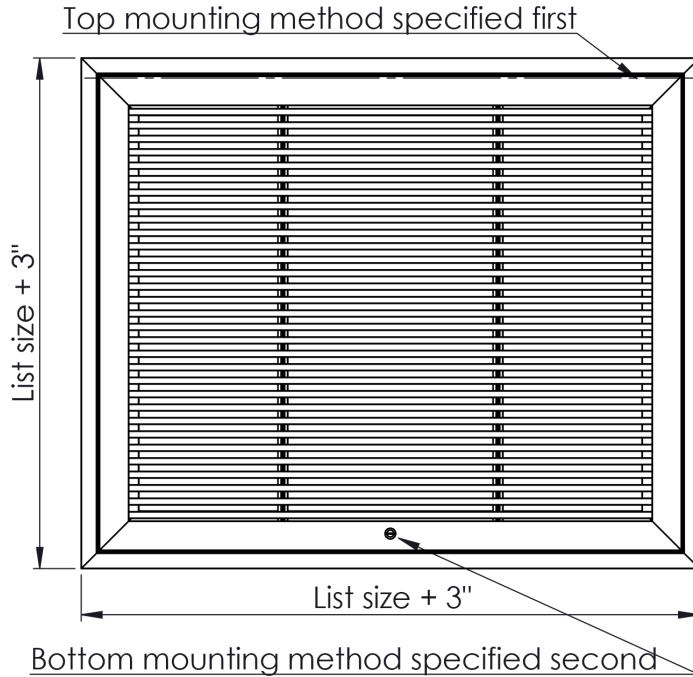

4" filter by others must be undersized by list-9/32".

1. Select a Blade Option

- 00 - 0° Deflection
- 01 - 0° Pencil Proof
- 15 - 15° Deflection
- 30 - 30° Deflection
- 82 - 0° Air Flow
- 84 - 0° Heel Proof

2. Select a Top Mounting Option

- B - Wire Hinge
- C - Nylon Thumb Screw
- D - Nylon Screen Tabs
- E - Security Screw

3. Select a Bottom Mounting Option

- C - Nylon Thumb Screw
- D - Nylon Screen Tabs
- E - Security Screw

4. Specify the Length x Height Dimensions

Inches MM _____ x _____

5. Select a Finish

- W - White
- S - Silver
- M - Mill

6. Select a Lead Time

- 3 Day Ship
- Next Friday
- Standard Delivery

Qty _____



Project / Location: _____

Architect: _____

Engineer: _____

Contractor: _____



BLADE OPTIONS

-00

0° 13/64" blades on 1/2" centers

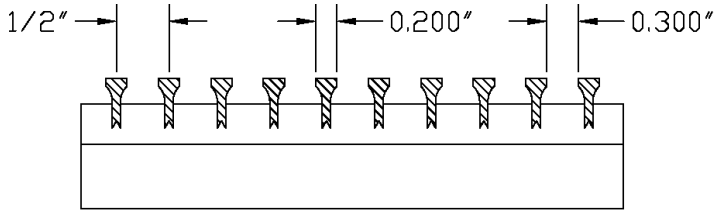

-01

0° 1/4" blades on 1/2" centers

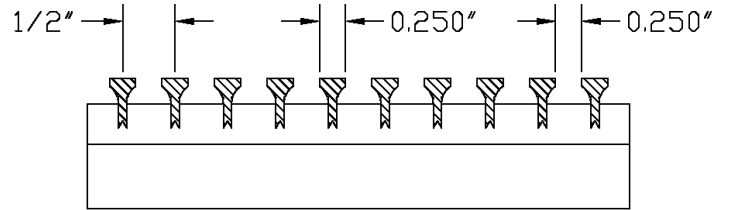

-15

15° 13/64" blades on 1/2" centers

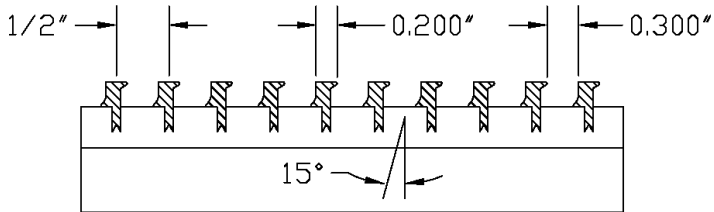

-30

30° 13/64" blades on 1/2" centers

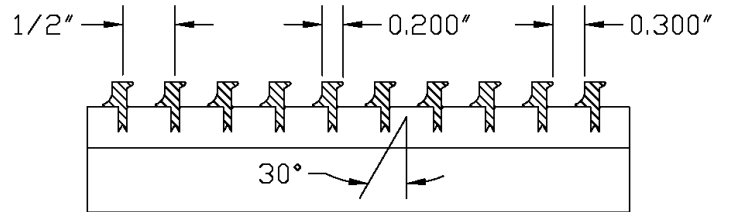

-82

0° 1/8" blades on 1/2" centers

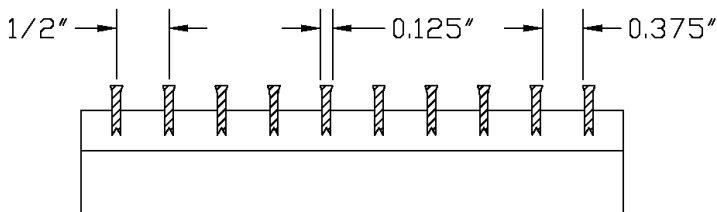

-84

0° 1/8" blades on 1/4" centers

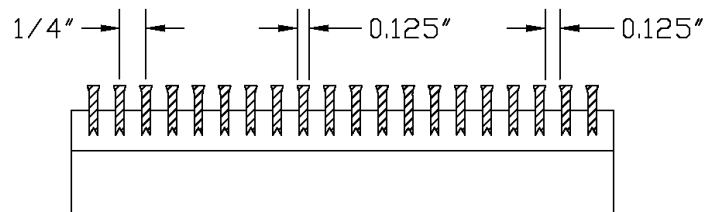

MOUNTING

Both a top & bottom mounting option is required for securing the grille to the outer frame.

Wire Hinge

B

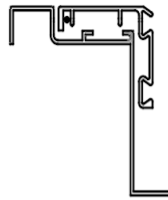
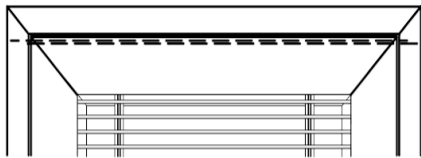

B - Wire Hinge mounting is for hinged access only, and grille face is connected to the outer filter frame.

B - Wire Hinge is only available for top mounting.

Nylon Thumb Screw

C

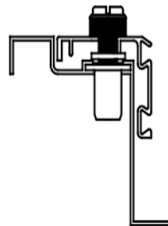
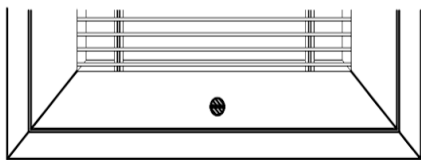

C - Nylon Thumb Screw

Nylon Screen Tabs

D

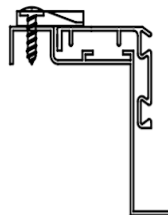
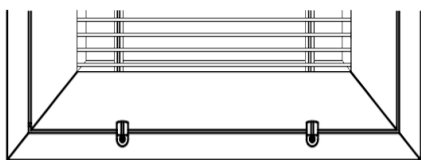

D - Nylon Screen Tab

Security Screw

E

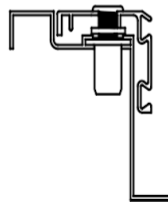
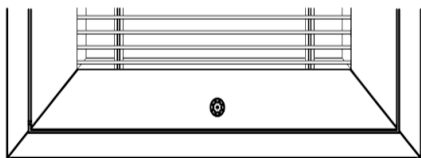

E - Security Key bit is required for access. The security key is available separately for order as a FG-KEY.